

## Rysunki wymiarowe. Styczniki 3 biegunowe

### Sterowanie napięciem przemiennym

CL00A3..., CL01A3..., CL02A3...

0.280 kg 0.280 kg 0.280 kg

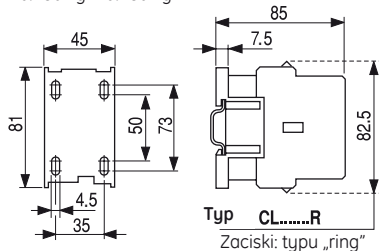

CL25A3...

0.270 kg

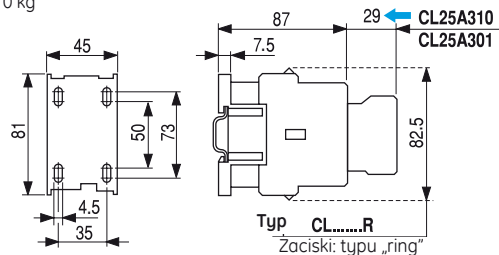

CL03A3..., CL04A3...

0.490 kg 0.500 kg

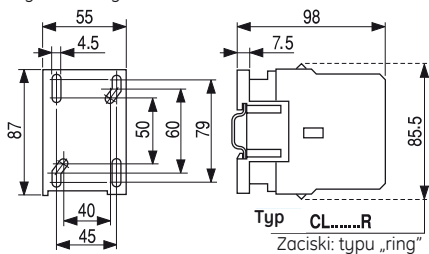

CL45A3...

0.520 kg

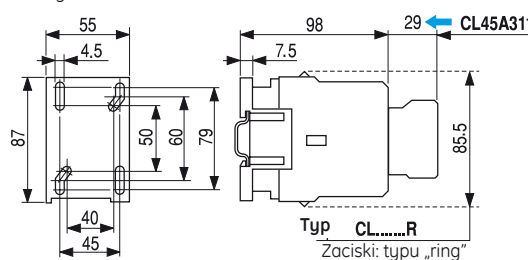

CL06A3..., CL07A3..., CL08A3...

1.105 kg 1.120 kg 1.130 kg

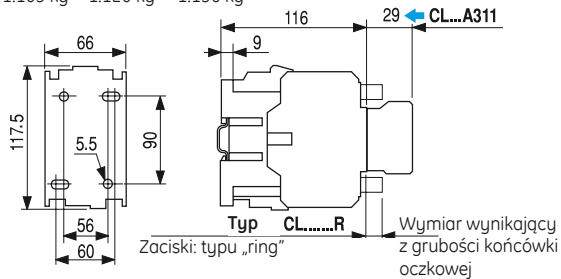

CL09A3..., CL10A3...

1.450 kg 1.470 kg

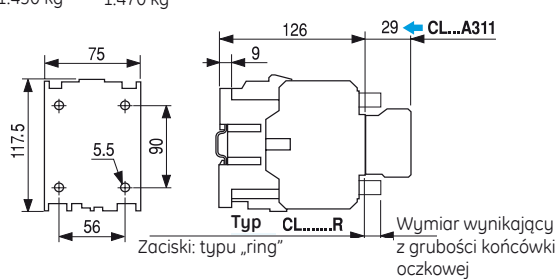

### Sterowanie napięcie stałym

CL00D3..., CL01D3..., CL02D3...

0.490 kg 0.490 kg 0.490 kg

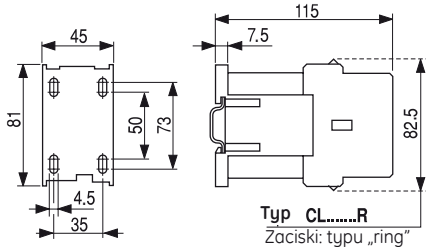

CL25D3...

0.480 kg

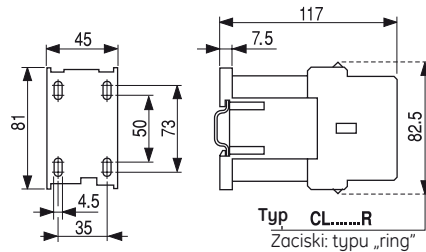

CL03D3..., CL04D3...

0.480 kg 0.835 kg

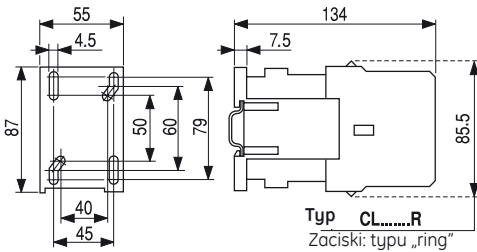

CL45D3...

0.825 kg

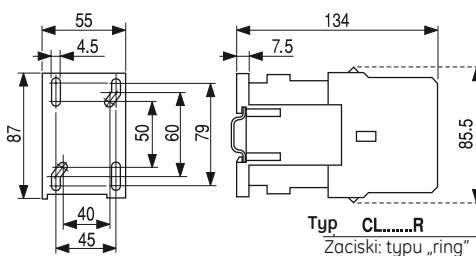

CL06D3..., CL07D3..., CL08D3...

1.110 kg 1.110 kg 1.110 kg

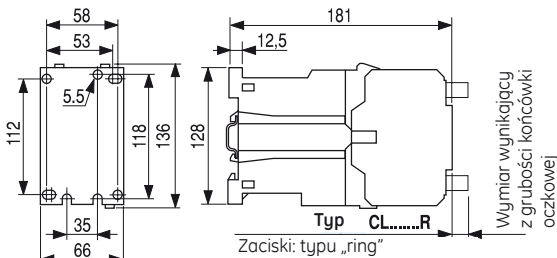

CL09D3..., CL10D3...

1.440 kg 1.440 kg

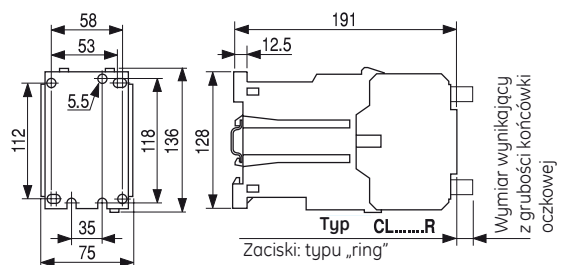

### Cewka z modułem elektronicznym

CL06E3..., CL07E3..., CL08E3...

1.095 kg 1.110 kg 1.120 kg

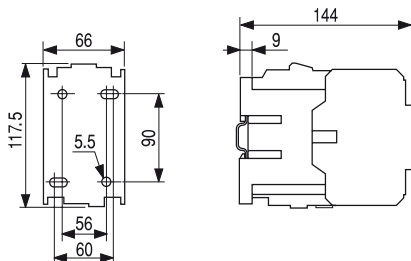

CL09E3..., CL10E3...

1.440 kg 1.460 kg

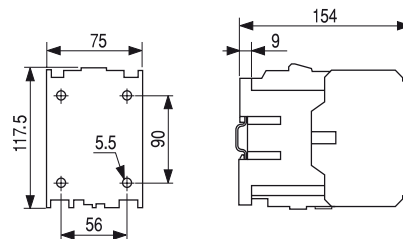

## Rysunki wymiarowe. Styczniki 4 biegunowe

### Sterowanie napięciem przemiennym

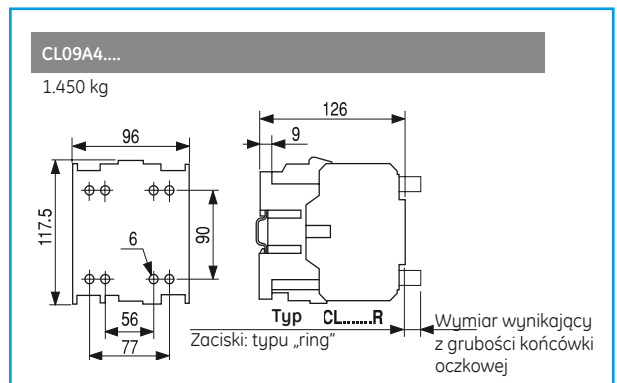
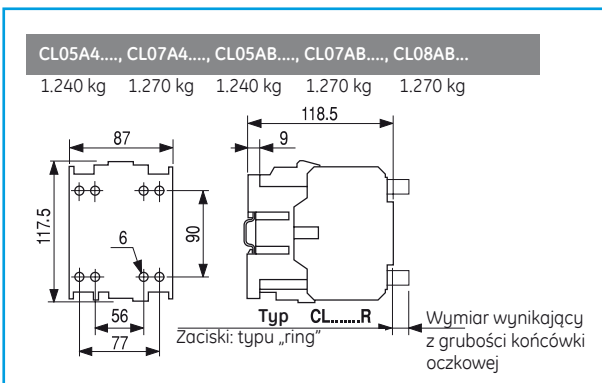
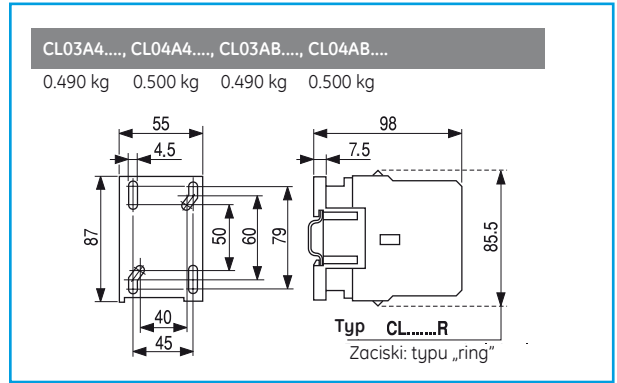
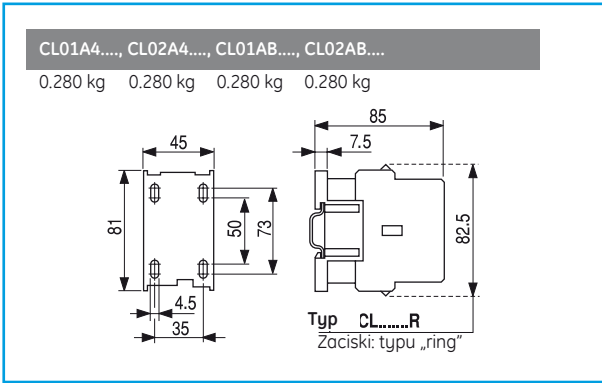

### Sterowanie napięciem stałym

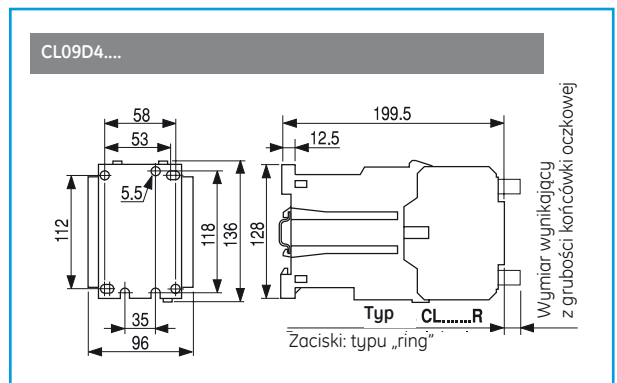
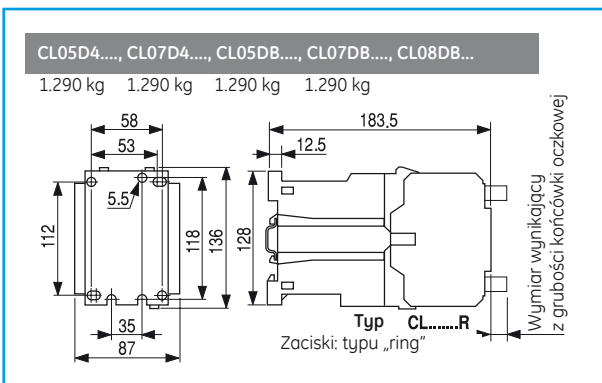
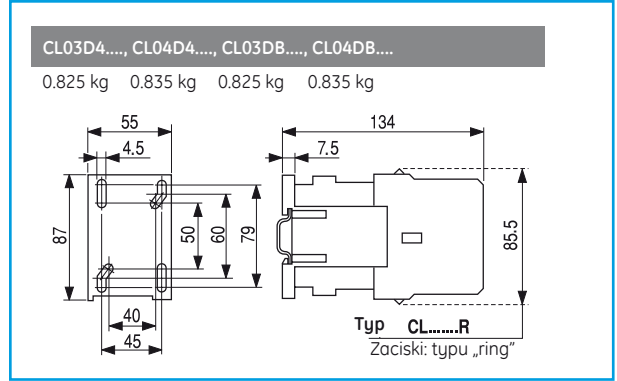
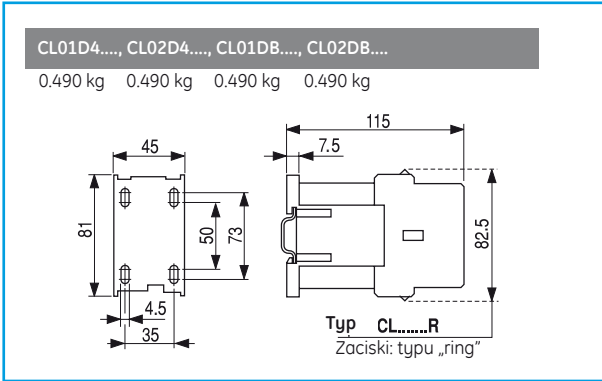

Cewka z modułem elektronicznym

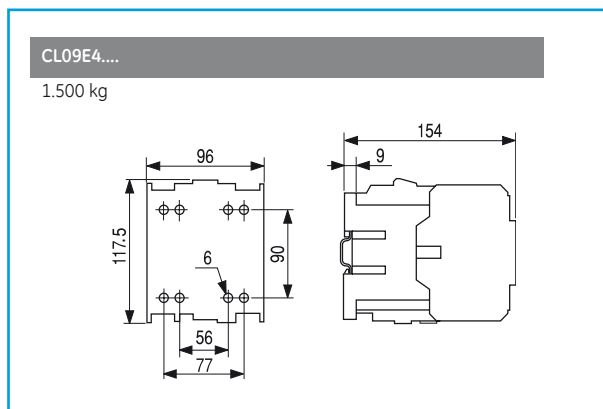
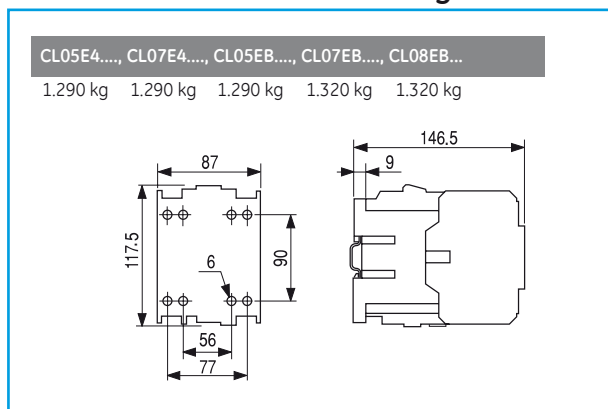

A

B

C

D

E

F

G

H

I

X

## Rysunki wymiarowe

### Bloki styków pomocniczych

Zaciski śrubowe

BCLF... 0.015 kg

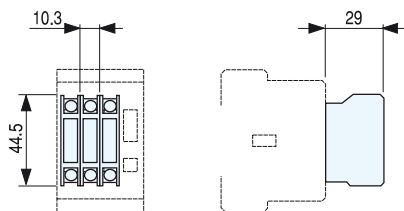

BCLL..., BRLL....

0.048 kg

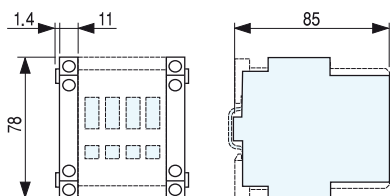

BTLF...

0.085 kg

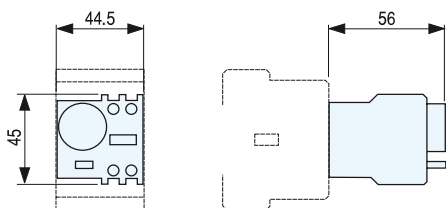

Zaciski do końcówek kablowych „ring”

BCRF... 0.015 kg

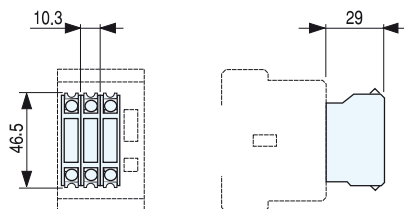

BTRF...

0.085 kg

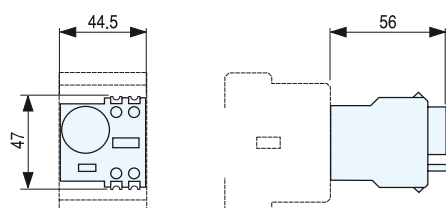

### Akcesoria

Ograniczniki przepięć

BSLR, BSLDZ, BSLV 0.020 kg

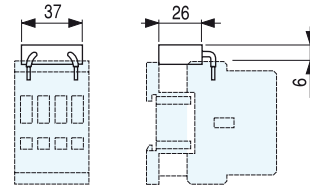

CL00 ... CL25

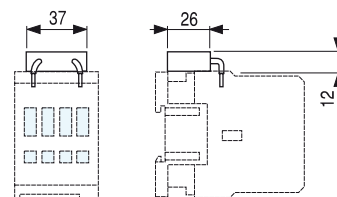

CL03 ... CL45

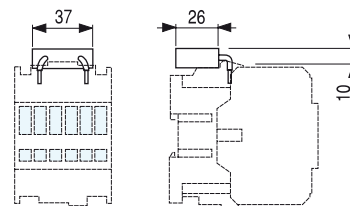

CL05 ... CL10

### Rygiel mechaniczny

RMLF 0.082 kg

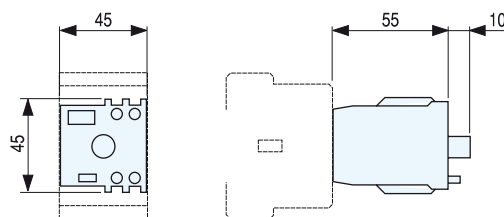

### Blokada mechaniczna/mechaniczno-elektryczna

BEL, BELA, BEL02, BELA02 0.025 kg

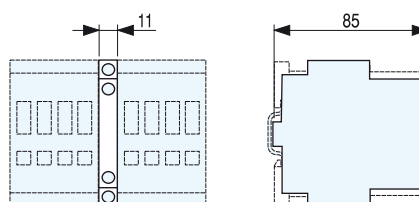

**Moduł czasowy elektroniczny**

BETL02, BETL45 0,040 kg

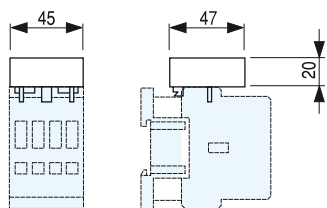

CL00 ... CL25

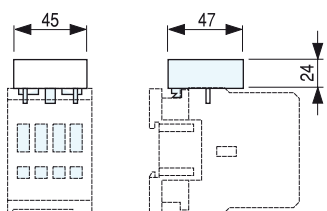

CL03 ... CL45

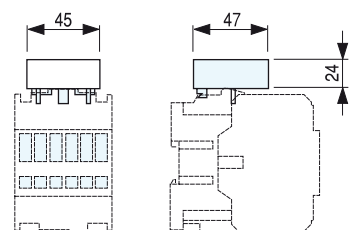

CL05 ... CL10

**Moduł interfejsu**

IMR..., IMRF..., IMSSD, IMAMS 0,020 kg

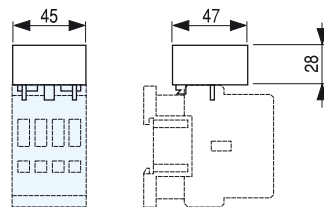

CL00 ... CL25

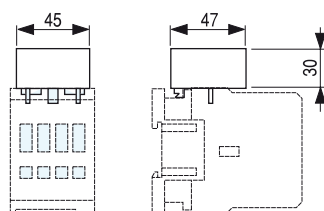

CL03 ... CL45

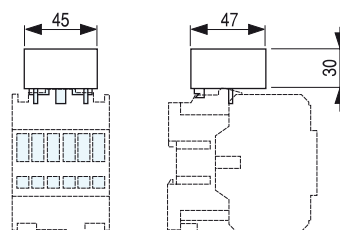

CL05 ... CL10

A

B

**C**

D

E

F

G

H

I

X