

Rysunki wymiarowe

Przełączniki termobimetalowe do styczników

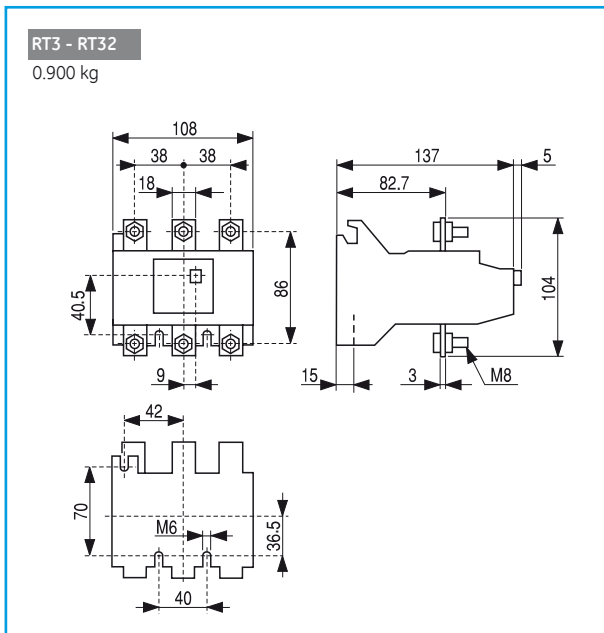
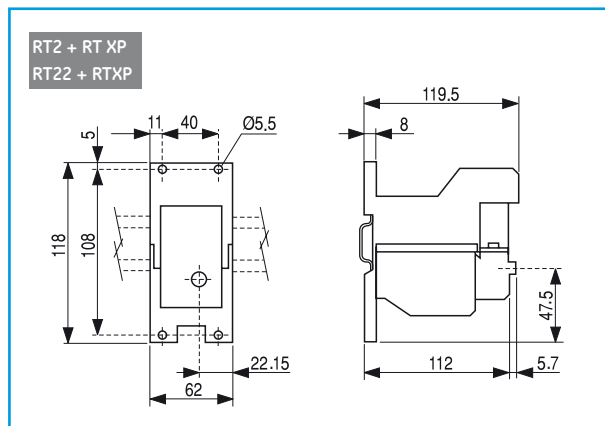
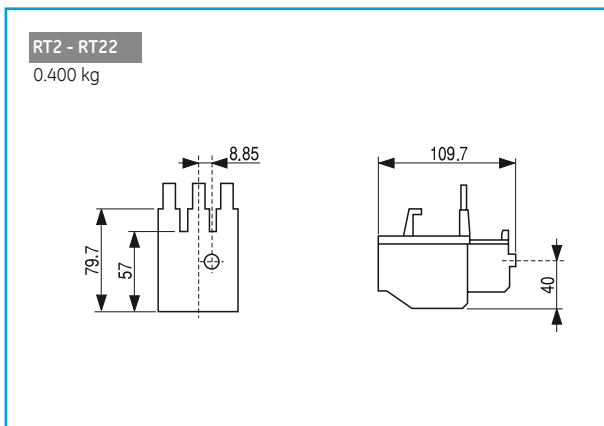
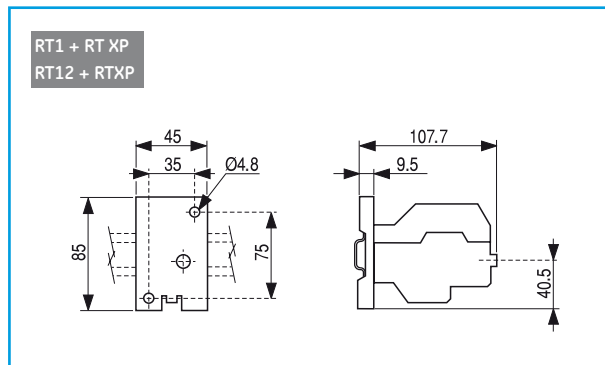
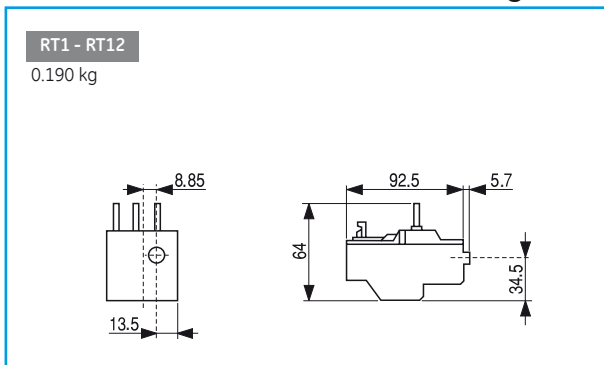

Przełączniki termobimetalowe do styczników

RT4LA...RT4LM

2.400 kg

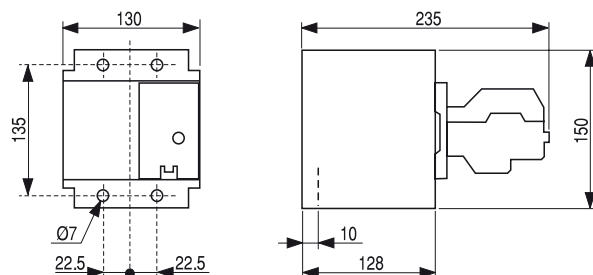

RT4/4LN...RT4/4LR

2.400 kg

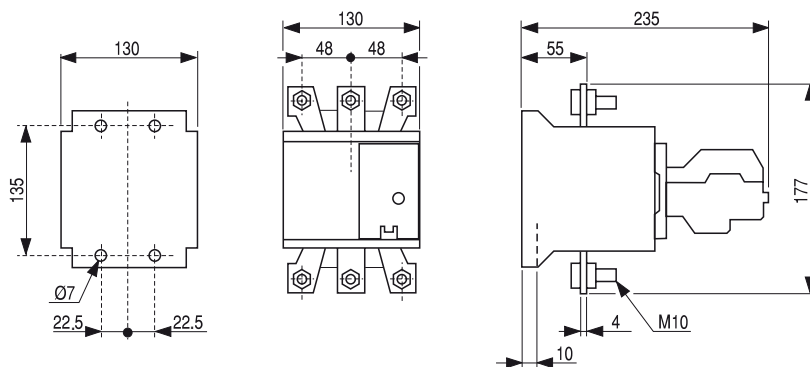

RT5 / 5L

0.875 kg

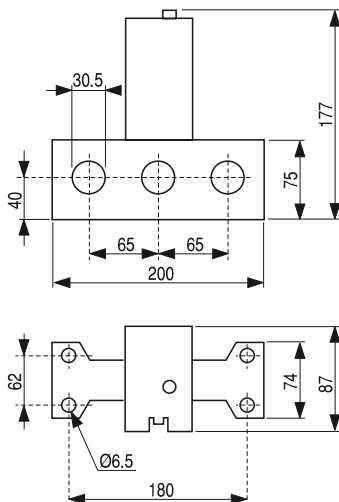

Elektryczny układ zdalnego kasowania

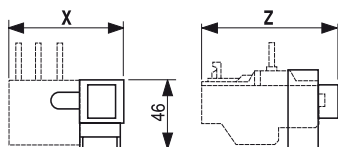

RTXRR + ...	X	Z
RT1	75	110
RT2	84	121
RT3	108	153
RT4	150	240
RT5	200	196

A

B

C

D

E

F

G

H

I

X